



mediterráneo
by franco furniture

mediterráneo



Acabados: 120 / 150 / Cristal ahumado / Tapizado Paris Cream

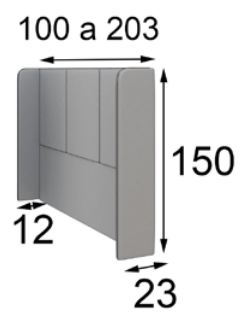

Medidas de cabecero

P-186

- 55030 Colchón 90
- 55031 Colchón 135
- 55032 Colchón 150
- 55033 Colchón 160
- 55034 Colchón 180
- 55035 Colchón 193
- 55036 Con base 90
- 55037 Con base 135
- 55038 Con base 150
- 55039 Con base 160
- 55040 Con base 180
- 55041 Con base 193

Medidas de mesitas de noche

P-122 55020

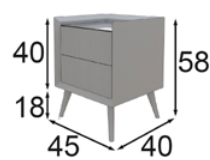

P-136 55022



Medidas de bancada

P-169



MD01

- 55105 Base para Colchón de 90
- 55106 Base para Colchón de 135
- 55107 Base para Colchón de 150
- 55108 Base para Colchón de 160
- 55109 Base para Colchón de 180
- 55110 Base para Colchón de 193

P-349 55025

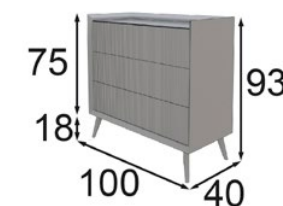

P-133 40054

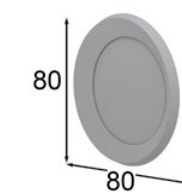

P-271 55027

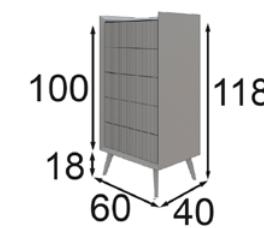

P-145 40047

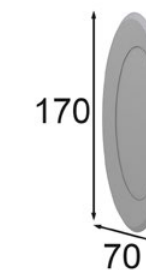





Acabados: 120 / 150 / Cristal ahumado / Tapizado Paris Light Blue

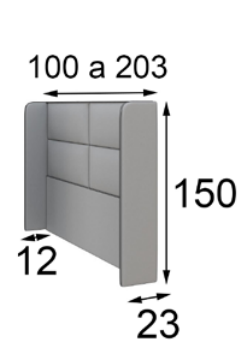

Medidas de cabecero

P-186

- 55045 Colchón 90
- 55046 Colchón 135
- 55047 Colchón 150
- 55048 Colchón 160
- 55049 Colchón 180
- 55050 Colchón 193
- 55051 Con base 90
- 55052 Con base 135
- 55053 Con base 150
- 55054 Con base 160
- 55055 Con base 180
- 55056 Con base 193

Medidas de mesitas de noche

P-122 55020

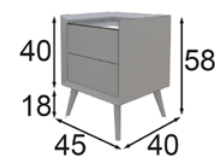

P-136 55022



Medidas de bancada

P-169



- 55105 Base para Colchón de 90
- 55106 Base para Colchón de 135
- 55107 Base para Colchón de 150
- 55108 Base para Colchón de 160
- 55109 Base para Colchón de 180
- 55110 Base para Colchón de 193



MD02



MD03

Acabados: 120 / 150
Cristal ahumado
Tapizado Paris Mouse

P-271 55027

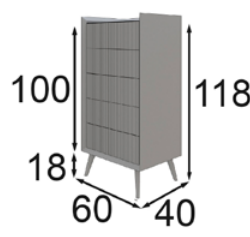

P-145 40047

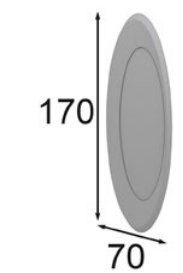

P-349 55025

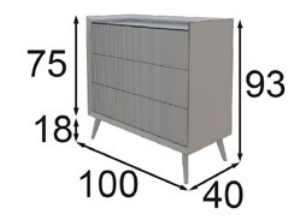

P-133 40054

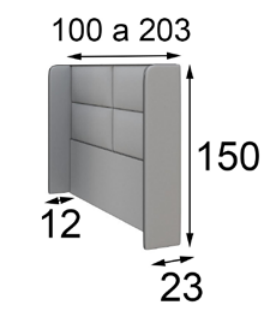
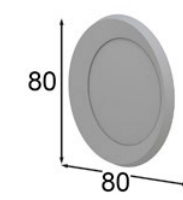

Medidas de cabecero

P-186

- | | |
|-------------------|--------------------|
| 55045 Colchón 90 | 55051 Con base 90 |
| 55046 Colchón 135 | 55052 Con base 135 |
| 55047 Colchón 150 | 55053 Con base 150 |
| 55048 Colchón 160 | 55054 Con base 160 |
| 55049 Colchón 180 | 55055 Con base 180 |
| 55050 Colchón 193 | 55056 Con base 193 |

Medidas de mesitas de noche

P-122 55020

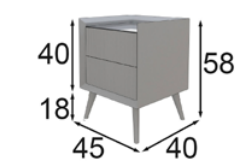

P-136 55022

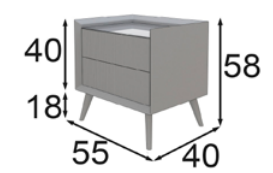

Medidas de bancada

P-169



- 55105 Base para Colchón de 90
- 55106 Base para Colchón de 135
- 55107 Base para Colchón de 150
- 55108 Base para Colchón de 160
- 55109 Base para Colchón de 180
- 55110 Base para Colchón de 193



P-145 40047

MD03

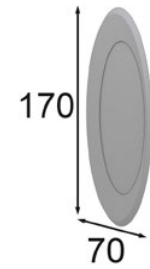

P-271 55027

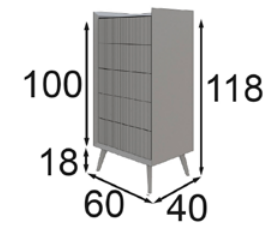

P-133 40054

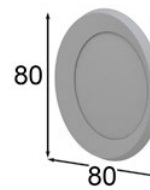

P-349 55025

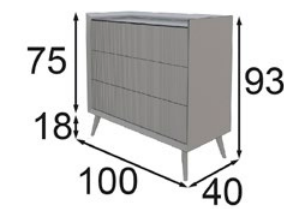

MD04

Acabados: 120 / 150
Cristal ahumado
Tapizado Paris Mouse





MD04

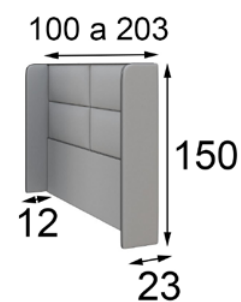

Medidas de cabecero

P-186

55045 Colchón 90	55051 Con base 90
55046 Colchón 135	55052 Con base 135
55047 Colchón 150	55053 Con base 150
55048 Colchón 160	55054 Con base 160
55049 Colchón 180	55055 Con base 180
55050 Colchón 193	55056 Con base 193

Medidas de mesitas de noche

P-122 55020



P-136 55022

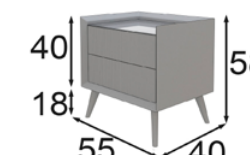

Medidas de bancada

P-169



55105 Base para Colchón de 90
55106 Base para Colchón de 135
55107 Base para Colchón de 150
55108 Base para Colchón de 160
55109 Base para Colchón de 180
55110 Base para Colchón de 193



MD05

Acabados: 120 / 150
Cristal ahumado
Tapizado Paris Mouse



P-271 55027

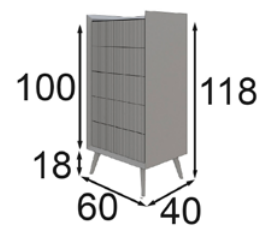

P-145 40047

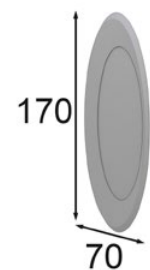

P-349 55025

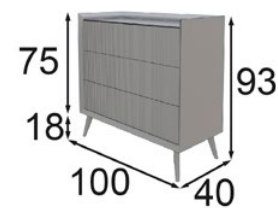

P-133 40054

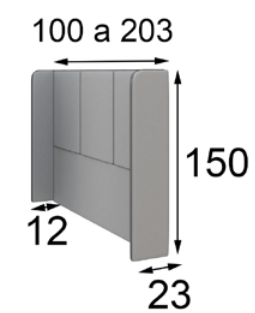
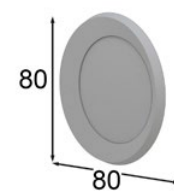

Medidas de cabecero

P-186

55030 Colchón 90	55036 Con base 90
55031 Colchón 135	55037 Con base 135
55032 Colchón 150	55038 Con base 150
55033 Colchón 160	55039 Con base 160
55034 Colchón 180	55040 Con base 180
55035 Colchón 193	55041 Con base 193

Medidas de mesitas de noche

P-122 55020



P-136 55022

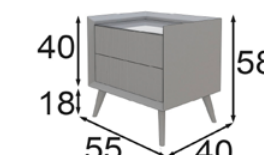

Medidas de bancada

P-169



55105 Base para Colchón de 90
55106 Base para Colchón de 135
55107 Base para Colchón de 150
55108 Base para Colchón de 160
55109 Base para Colchón de 180
55110 Base para Colchón de 193

MD05



P-471 42524

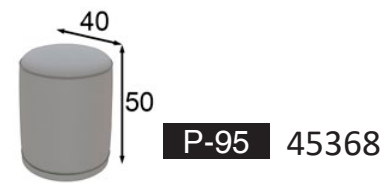
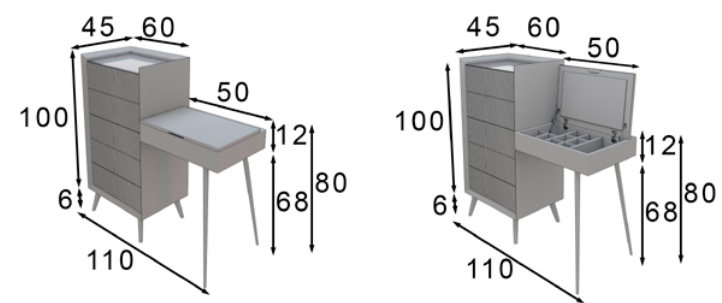

La parte de tocador irá por defecto al lado derecho como aparece en miniatura. Si se quiere en lado izquierdo se debe indicar en pedido.



P-471 42524

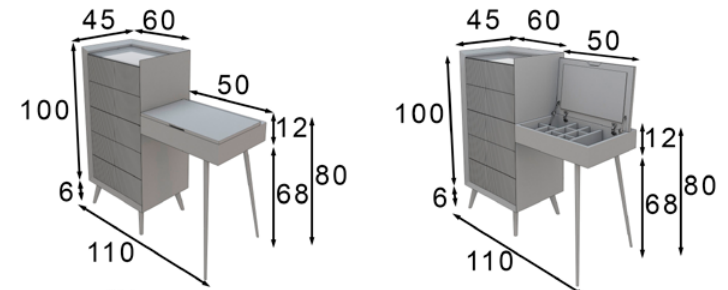

La parte de tocador irá por defecto al lado derecho como aparece en miniatura. Si se quiere en lado izquierdo se debe indicar en pedido.